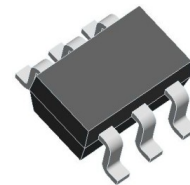
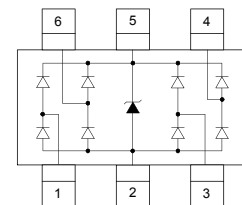

SOT-363 Plastic-Encapsulate ESD Protection Array
DESCRIPTION

ESD0504F is an ultra-low capacitance Transient Voltage Suppressor (TVS) designed to protection For high-speed data interfaces. With typical capacitance of 0.20pF (I/O to I/O) only, ESD0504F is designed to protect parasitic-sensitive systems against over-voltage and over-current transsient events. It complies with IEC 61000-4-2 (ESD), Level 4 ($\pm 15\text{kV}$ air, $\pm 8\text{kV}$ contact discharge), IEC 61000-4-4 (electrical fast transient - EFT) (40A, 5/50 ns), very fast charged devicee model (CDM) ESD and cable discharge event (CDE), etc. ESD0504F uses ultra-small SOT-363 package. Each ESD0504F device can protect four high-speed data line one Vcc line. The combined features of ultra-low capacitance, small size and high ESD robustness make ESD0504F ideal for high-speed data ports and high-frequency lines (e.g., HDMI&DVI) applications, The low clamping voltage of the ESD0504F guarantess a minimum strese on the protected IC.

Features

- ◆ Transient protection for high speed data lines
- ◆ IEC61000-4-2 (ESD) $\pm 25\text{kV}$ (air), $\pm 20\text{kV}$ (contact)
- ◆ IEC61000-4-4 (EFT) 40A (5/50ns)
Cable Discharge Event (CDE)
- ◆ Package optimized for hingh-speed lines
- ◆ Protects four data line and one Vcc line
- ◆ Low Capacitance :0.20pF(I/O to I/O)
- ◆ Low clamping voltage
- ◆ Low leakage current
- ◆ Each I/O pin can withstand over 1000 ESD strikes for $\pm 8\text{KV}$ coantact discharge

Pin Configuration

Circuit Diagram

Mechanical Characteristics

- ◆ Package: SOT-363
- ◆ Flammability Rating: UL 94V-0
- ◆ Packaging: Tape and Reel
- ◆ High temperature soldering guaranteed: $260\text{ }^\circ\text{C}/10\text{s}$
- ◆ Marking: F54

Applications

- ◆ Serial ATA
- ◆ High Definition Multi Interface (HDMI)
- ◆ MDDI Ports
- ◆ USB 2.0/3.0 Power and Data Line Protection
- ◆ Display Ports
- ◆ Digital Visual Interfacsess (DVI)

Absolute Maximum Ratings ($T_A=25\text{ }^\circ\text{C}$ unless otherwise specified)

Parameter	Symbol	Value	Unit
ESD per IEC 61000-4-2 (Air)	V _{ESD}	± 25	KV
ESD per IEC 61000-4-2 (Contact)		± 20	
Peak Pulse Power(8/20us)	P _{PP}	60	W
Operating Temperature	T _{OPT}	-55 to +125	$^\circ\text{C}$
Storage Temperature	T _{STG}	-55 to +150	$^\circ\text{C}$
Lead Solder Temperature – Maximum (10 Second Duration)	T _L	260(10 sec.)	$^\circ\text{C}$

The above data are for reference only.

Electrical Characteristics ($T_A=25^\circ\text{C}$ unless otherwise specified)

Symbol	Param	Test Condition	Min	Typ	Max	Units
V_{RWM}	Reverse Working Voltage	Any I/O pin to GND			5.0	V
V_{BR}	Reverse Breakdown Voltage	$I_T = 1\text{mA}$ Any I/O pin to GND	6.0		9.0	V
I_R	Reverse Leakage Current	$V_{RWM} = 5\text{V}$ Any I/O pin to GND			1.0	μA
V_C	Clamping Voltage	$I_{PP} = 1\text{A}$, $t_p = 8/20\mu\text{s}$ Any I/O pin to GND			10	V
		$I_{PP} = 4\text{A}$, $t_p = 8/20\mu\text{s}$ Any I/O pin to GND			15	V
		$I_{PP} = 8\text{A}$, $t_p = 8/20\mu\text{s}$ Vcc pin to GND			15	V
C_{ESD}	Parasitic Capacitance	$V_R = 0\text{V}$, $f = 1\text{MHz}$ Between I/O and I/O		0.20	0.30	pF
		$V_R = 0\text{V}$, $f = 1\text{MHz}$ Between I/O and GND		0.45	0.50	pF
		$V_R = 0\text{V}$, $f = 1\text{MHz}$ Between Vcc and GND		0.80		pF

Note: I/O Pins are pin 1,3,4,6. Pin 5 is Vcc. Pin 2 is GND.

ELECTRICAL CHARACTERISTICS CURVE

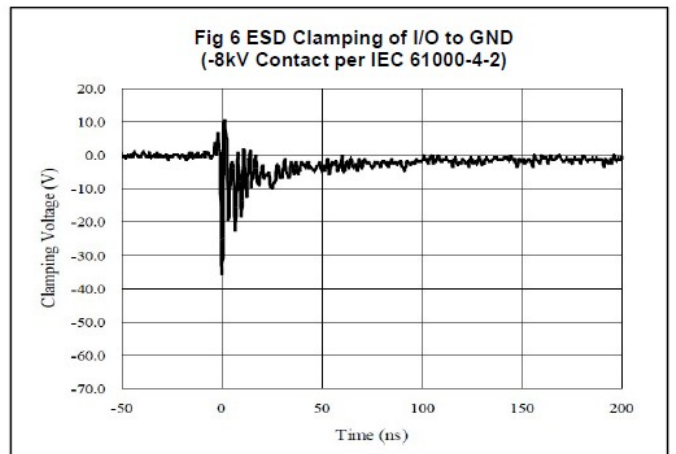
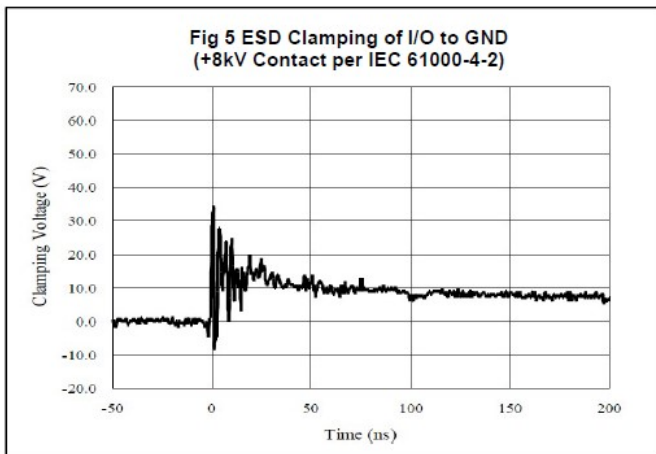
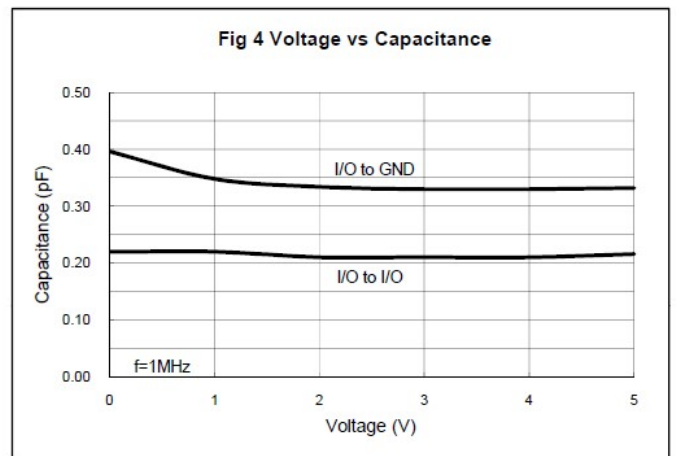
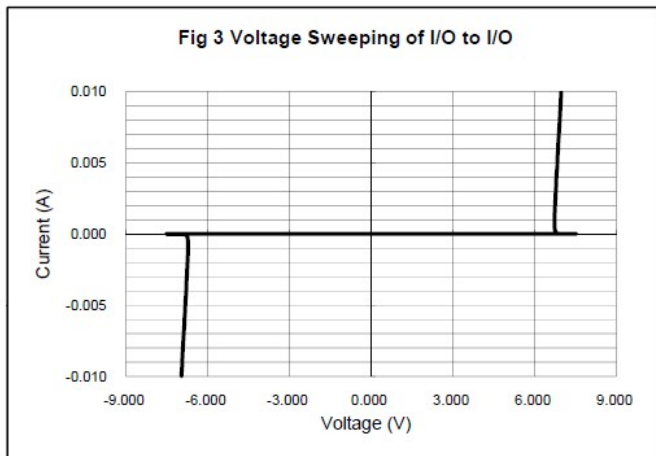
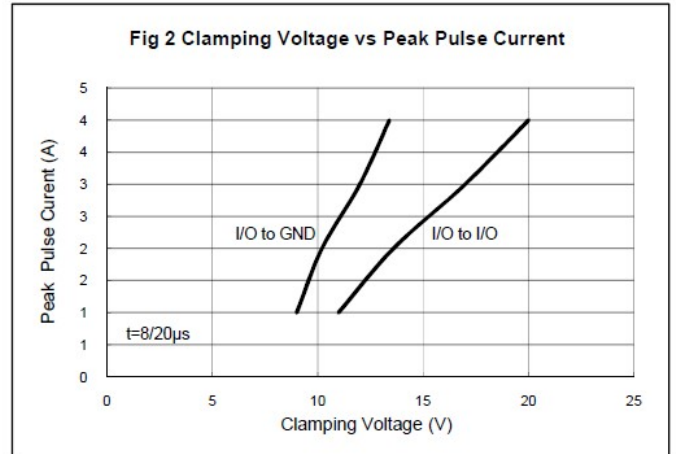
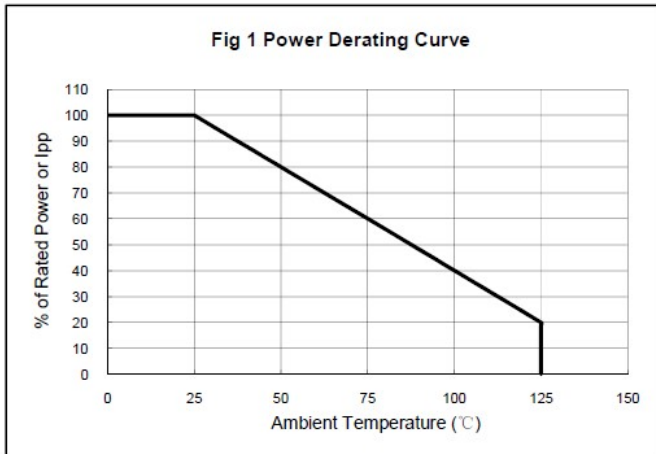

The curve above is for reference only.

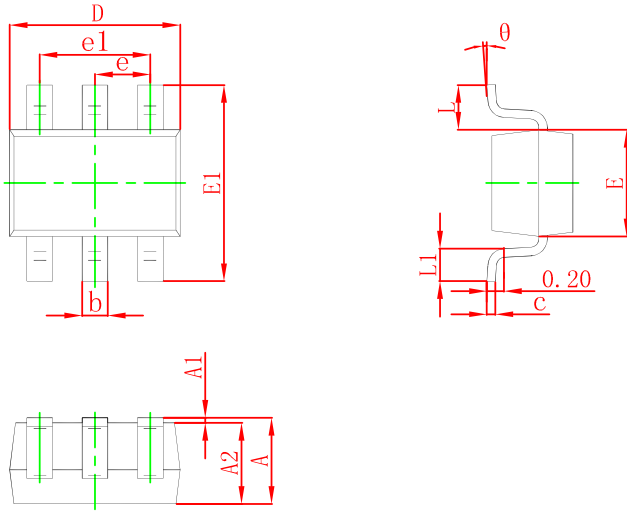
PACKAGE OUTLINE AND PAD LAYOUT INFORMATION
SOT-363 Package Outline Dimensions

Symbol	Dimensions in Millimeters		Dimensions in Inches	
	Min	Max	Min	Max
A	0.900	1.100	0.035	0.043
A1	0.000	0.100	0.000	0.004
A2	0.900	1.000	0.035	0.039
b	0.150	0.350	0.006	0.014
c	0.100	0.150	0.004	0.006
D	2.000	2.200	0.079	0.087
E	1.150	1.350	0.045	0.053
E1	2.150	2.400	0.085	0.094
e	0.650 TYP		0.026 TYP	
e1	1.200	1.400	0.047	0.055
L	0.525 REF		0.021 REF	
L1	0.260	0.460	0.010	0.018
θ	0°		8°	

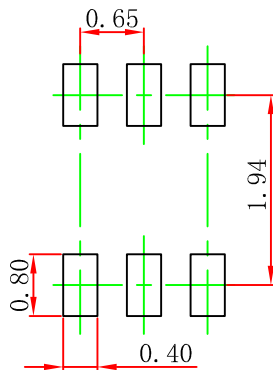
Suggested Pad Layout

Note:

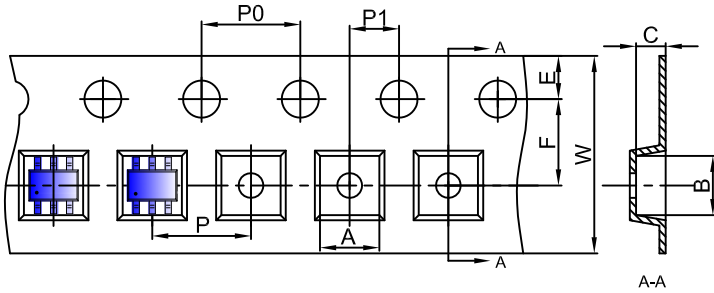
1. Controlling dimension: in/millimeters.
2. General tolerance: ±0.05mm.
3. The pad layout is for reference purposes only.

TAPE AND REEL INFORMATION
SOT-363 Embossed Carrier Tape

Packaging Description:

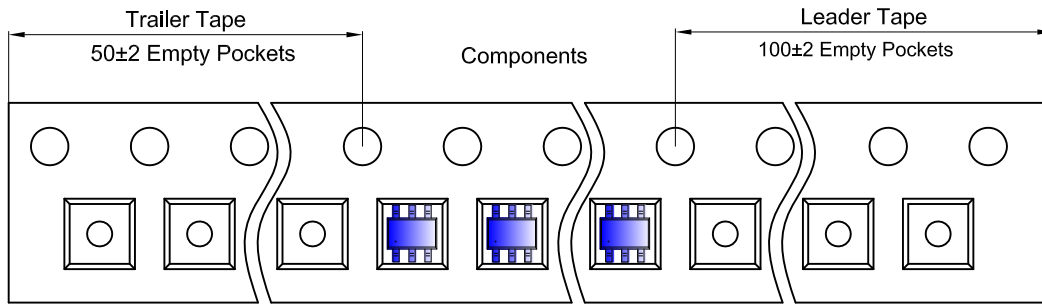
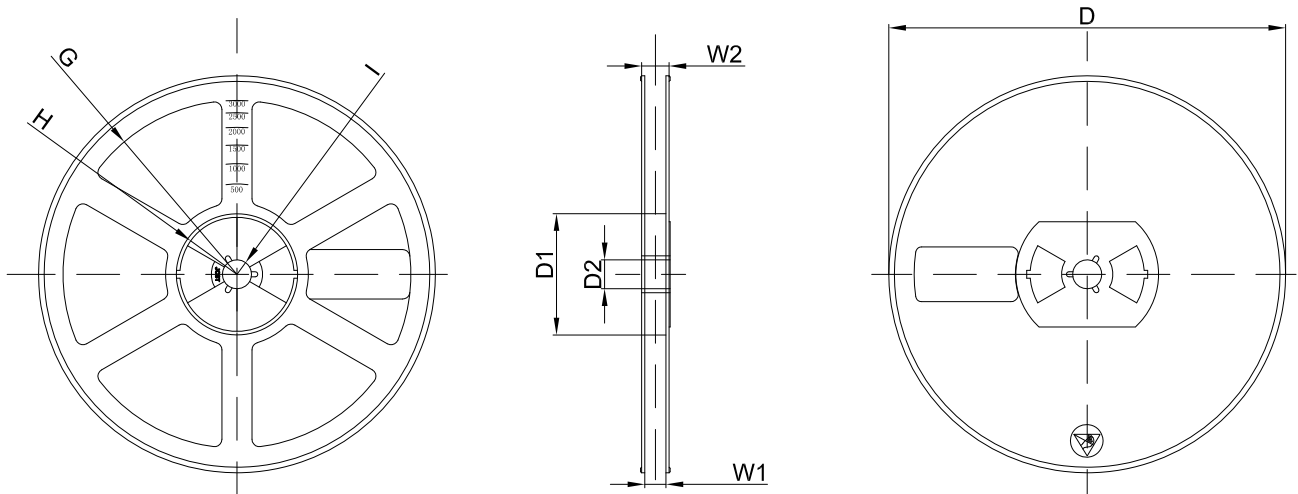
SOT-363 parts are shipped in tape. The carrier tape is made from a dissipative (carbon filled) polycarbonate resin. The cover tape is a multilayer film (Heat Activated Adhesive in nature) primarily composed of polyester film, adhesive layer, sealant, and anti-static sprayed agent. These reeled parts in standard option are shipped with 3,000 units per 7" or 18cm diameter reel. The reels are clear in color and is made of polystyrene plastic (anti-static coated).

Dimensions are in millimeter										
Pkg type	a	B	C	d	E	F	P0	P	P1	W
SOT-363	2.25	2.55	1.20	Ø1.50	1.75	3.50	4.00	4.00	2.00	8.00

SOT-363 Tape Leader and Trailer

SOT-363 Reel

Dimensions are in millimeter								
Reel Option	D	D1	D2	G	H	I	W1	W2
7" Dia	Ø178.00	54.40	13.00	R78.00	R25.60	R6.50	9.50	12.30

REEL	Reel Size	Box	Box Size(mm)	Carton	Carton Size(mm)	G.W.(kg)
3000 pcs	7 Inch	45,000 pcs	203×203×195	180,000 pcs	438×438×220	